

ACSL

Quick Start Guide
クイックスタートガイド

V1.0

蒼天
SOTEN

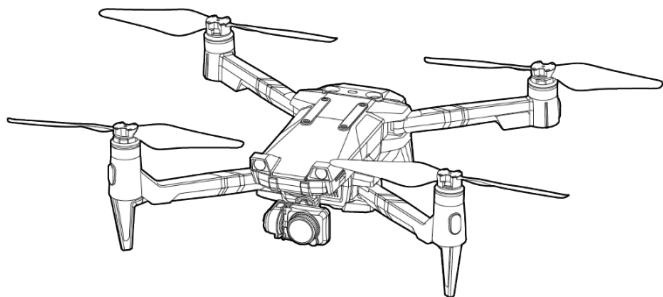

1

Installing the TAKEOFF App in Android

Android に TAKEOFF をインストールする

Google Play で「TAKEOFF」と検索する

Search for "TAKEOFF" on Google Play

Google Play and the Google Play logo are trademarks of Google LLC.

Google Play および Google Play ロゴは、Google LLC の商標です。

2

Unfolding the Arms and Mounting the Camera

アームを広げてカメラを取り付ける

1

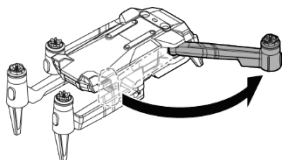

2

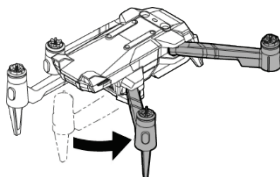

3

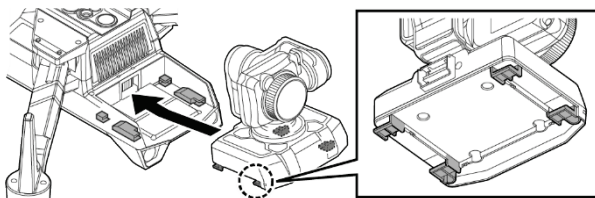

3

Attaching the Propellers

プロペラを取り付ける

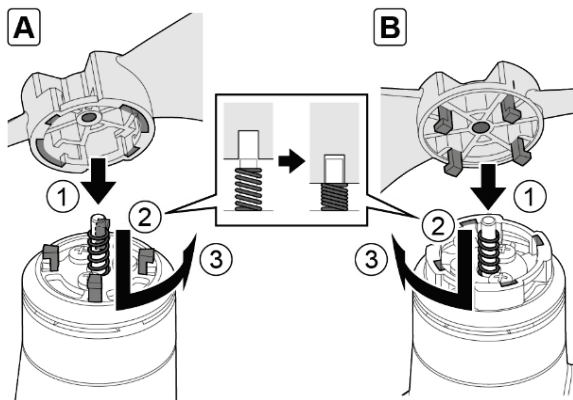
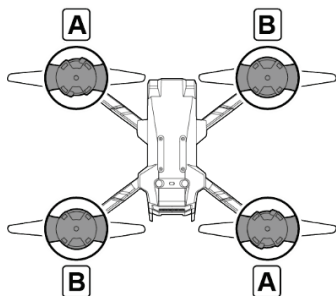

4

Preparing the Remote Controller

送信機を準備する

1

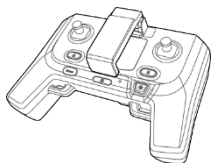

2

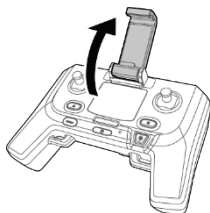

3



4

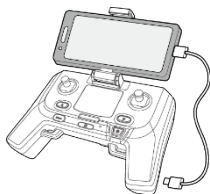

5

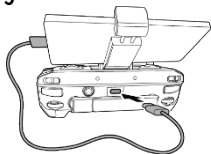

6

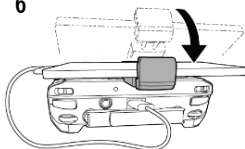

5

Mounting / Removing the Battery

バッテリーの取り付け、取り外し

Mounting

取り付け

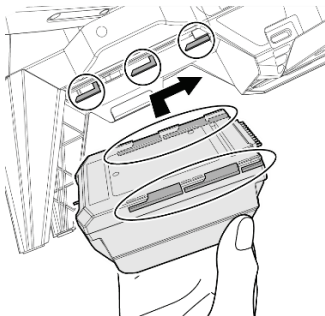
**Removing**

取り外し

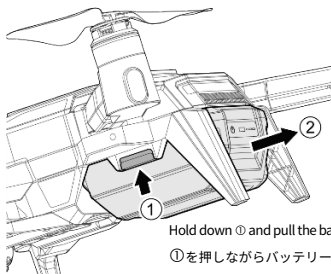



Hold down ① and pull the battery towards ②.

①を押しながらバッテリーを②の方向に引く。

6

Powering ON/OFF and Checking the Battery Level

電源のオン/オフとバッテリーの残量確認

	Press the button for 1 second to TURN ON ボタン 1 秒押しで電源オン
	Press the button for 1 second. The device will TURN OFF within 5 seconds. ボタンを 1 秒押し、5 秒後に電源オフになる

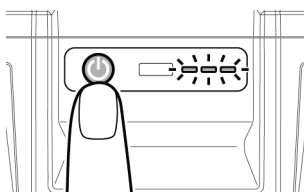

After TURNING ON, 3 small LEDs show the battery charge
電源オン後、3 つの LED でバッテリー残量を表示

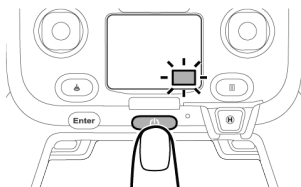

The icon on the lower-right shows the battery charge
右下のアイコンでバッテリー残量を表示

7

Charging the Battery

バッテリーを充電する

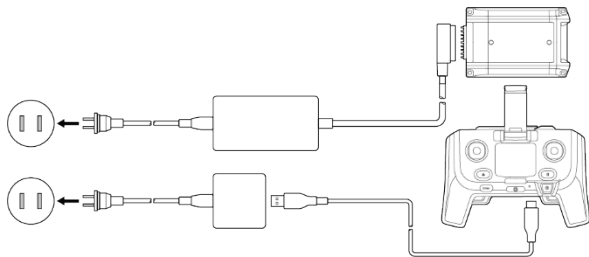

8

Selecting the Radio Controller Mode

モードを選択する

1

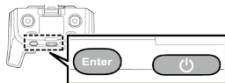

Press these buttons at the same time.
これらのボタンを同時に押す。

2

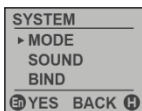

3

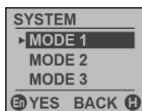

4

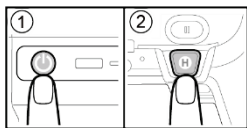

5



Mode 1

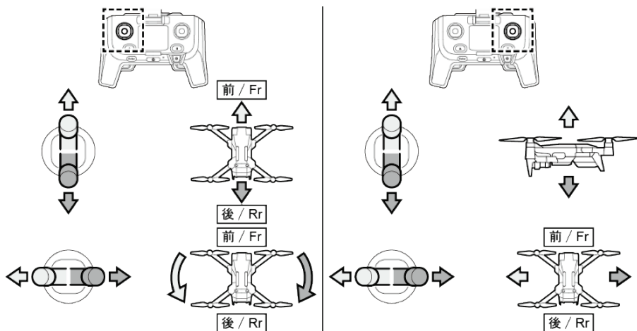

Support page: <https://www.acsl.co.jp/drone-manual>

e-mail: ACSL-drone@acsl.co.jp